

# TYPE 1 HINGE COVER ENCLOSURE

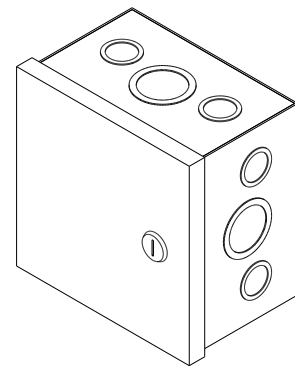

## STANDARD KNOCKOUT PATTERNS

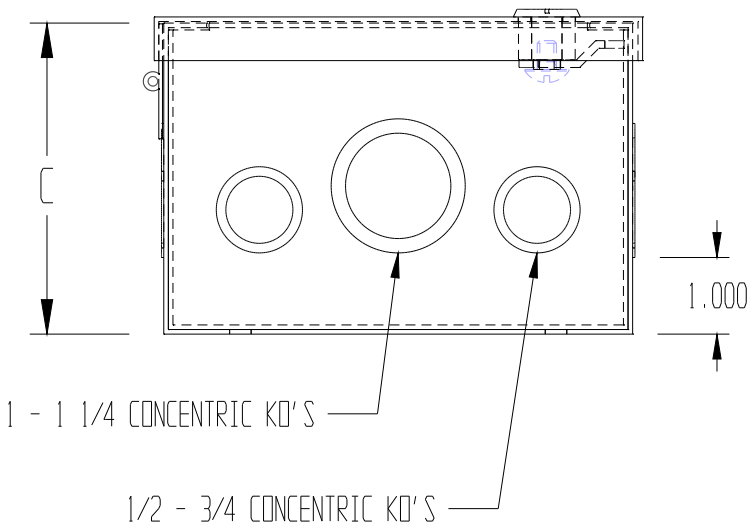
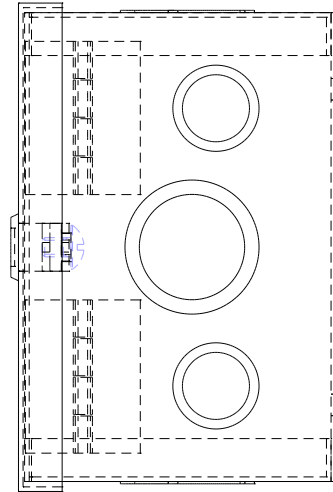
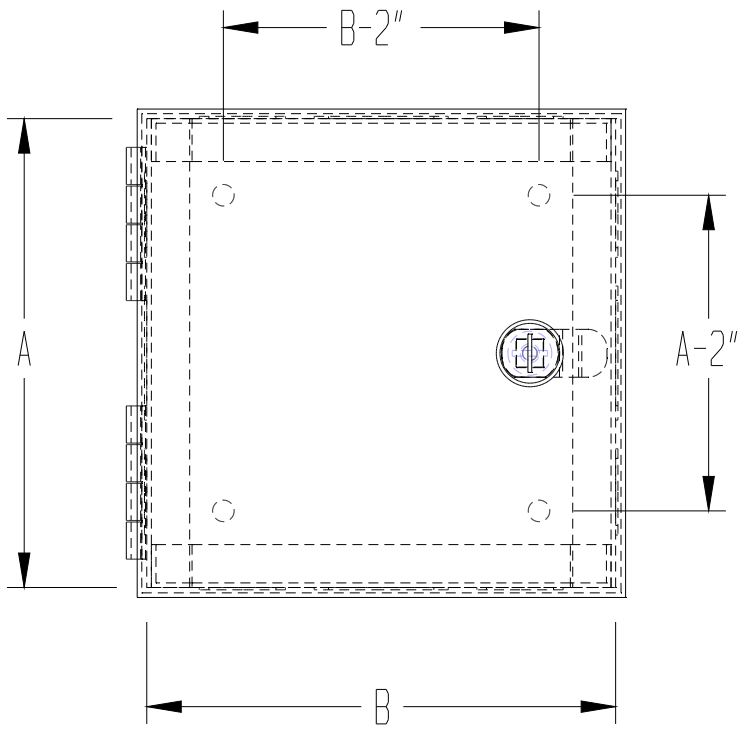
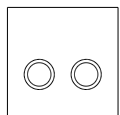

4"

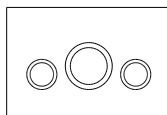

6"

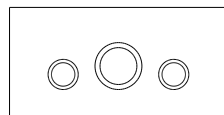

8"

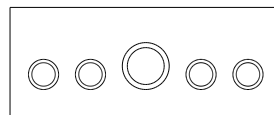

10"

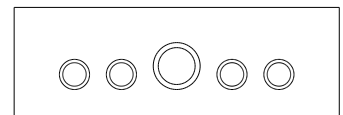

12"